



Valves Technical Utility Ball Valves



Features - PVC White, PVC Gray & CPVC

A high quality, economical quarter-turn shutoff valve designed for irrigation, pool and spa, and general purpose applications. IPS sizes 1/2" - 3" available in PVC White, PVC Gray or CPVC with socket or threaded end connectors. Size 4" available in PVC White with socket or threaded end connectors. 6" size available in PVC White with socket end connectors and high-efficiency lever style handle for easier operation.

- Chemical & Corrosion Resistant PVC or CPVC Construction
- Economical Sealed Unit
- Schedule 80 Full-Port Design
- High Impact Polypropylene Handle
- Spears® Single O-ring Safe-T-Shear® Stem Design
- EPDM O-rings
- PTFE/HDPE Floating Seat Design
- Sizes 1/2" - 6" Pressure Rated to 150 psi @ 73°F
- NSF® Certified for Potable Water use
- Assembled with Silicone-Free, Water Soluble lubricant

Note: Valve sizes 4" and 6" are not available in CPVC.
Refer to Compact Ball Valve
Valve size 6" uses Lever Handle (not shown)

Sample Engineering Specification

All thermoplastic ball valves shall be Utility sealed unit type constructed from PVC Type I, ASTM D 1784 Cell Classification 12454 or CPVC Type IV, ASTM D 1784 Cell Classification 23447. All O-rings shall be EPDM. All valves shall have Safe-T-Shear® stem and Polypropylene handle. All valves shall be certified by NSF International for use in potable water service. All valves shall be pressure rated at 150 psi for water at 73°F, as manufactured by Spears® Manufacturing Company.

Quick-View Valve Selection Chart

Valve Size	O-ring Material	PVC Part Number ^{1, 2}		Pressure Rating
		Socket	Threaded	
1/2	EPDM	2622-005	2621-005	150 psi Non-Shock Water @ 73°F
3/4	EPDM	2622-007	2621-007	
1	EPDM	2622-010	2621-010	
1-1/4	EPDM	2622-012	2621-012	
1-1/2	EPDM	2622-015	2621-015	
2	EPDM	2622-020	2621-020	
2-1/2	EPDM	2622-025	2621-025	
3	EPDM	2622-030	2621-030	
4	EPDM	2622-040	2621-040	
6	EPDM	2622-060	---	

1: For CPVC valves, add the letter "C" to part numbers listed (e.g., 2621-005**C**).
2: For PVC Gray, add the letter "G" to part numbers listed (e.g. 2621-005**G**).

Valves Technical Utility Ball Valves

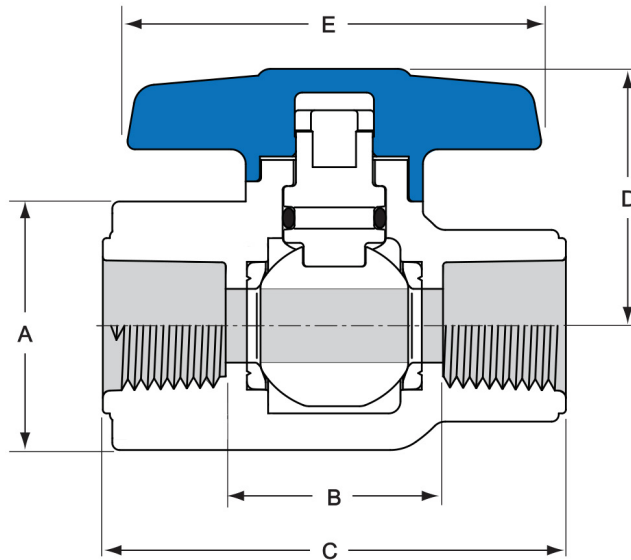

Dimensions, Weights & C_v Values

Nominal Size	Dimension Reference (inches, ± 1/16)						Approx. Wt. (Lbs.)		C _v ² Values
	A	B ¹		C	D	E ³	PVC	CPVC	
		Socket	Threaded						
1/2	1-7/16	1-3/16	1-7/32	2-5/8	1-11/16	2-3/4	.16	.17	46
3/4	1-25/32	1-7/16	1-7/16	2-15/16	2-1/32	3-1/4	.25	.27	91
1	2-1/32	1-5/8	1-5/8	3-3/8	2-7/16	3-1/2	.34	.36	160
1-1/4	2-9/16	1-31/32	2	3-7/8	2-3/4	3-3/4	.57	.60	306
1-1/2	2-15/16	2-1/2	2-15/32	4-5/8	3-1/8	4-1/4	.88	.90	429
2	3-9/16	2-13/16	3-3/16	5-3/16	3-7/8	5	1.34	1.34	755
2-1/2	4-5/16	3-1/2	4-7/16	7	4-1/8	5-5/8	2.31	2.41	1126
3	5-11/32	4-5/32	5-3/16	8	5-9/16	7-3/4	4.18	4.67	1660
4	6-11/16	5-1/8	6-7/32	9-3/16	6-5/32	9-1/8	8.00	N/A	3129
6 ³	10-3/16	8-3/32	---	14-3/16	8-5/32	14-3/32	23.24	N/A	7942

1: Valve Lay Length

2: Gallons per minute at 1 psi pressure drop. Values calculated from valve laying length, based on derivative of Hazen-Williams equation with surface roughness factor of C=150.

3: 6" valve has lever handle, dimension is from valve stem centerline (not illustrated)

Temperature Pressure Rating

System Operating Temperature °F (°C)		73 (23)	100 (38)	110 (43)	120 (49)	130 (54)	140 (60)	150 (66)	160 (71)	170 (77)	180 (82)	190 (88)
Valve Pressure Rating psi (MPa)	PVC	150 (1.03)	93 (.64)	75 (.52)	60 (.41)	45 (.31)	33 (.23)	-0- (-0-)	-0- (-0-)	-0- (-0-)	-0- (-0-)	-0- (-0-)
	CPVC	150 (1.03)	23 (.85)	110 (.76)	98 (.68)	86 (.58)	75 (.52)	68 (.47)	60 (.41)	48 (.33)	38 (.26)	-0- (-0-)