



Mission Rubber Company LLC

1660 Leeson Lane
 Corona, CA 92879
 (800) 854-9991 • Fax (800) 637-4601
 missionrubber.com

**For Installations
 Requiring a Standard
 No Hub Coupling**

MISSION
 RUBBER COMPANY

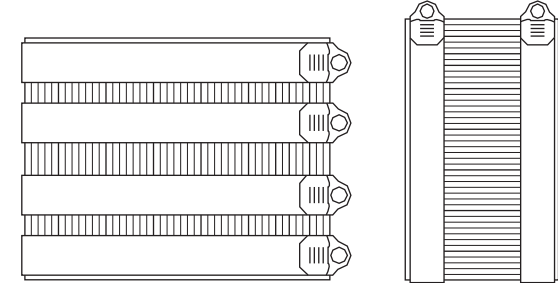

SIZES 1½" THROUGH 4" - 2 BANDS
 SIZES 5" THROUGH 10" - 4 BANDS

MEETS:
 ASTM C 1277
 ASTM C 564
 ASTM A240/A240M
 CSA B602
 CISPI® 310
 UPC 0743



CISPI 310

No Hub Coupling - Submittal

Standard Couplings for Hubless Cast Iron Pipe and Fittings

PROJECT _____
 ENGINEER _____
 CONTRACTOR _____

MATERIALS	
Band	Series 301 ASTM stainless steel
Screw Housing	Series 301 ASTM stainless steel
Screw Saddle	Series 301 ASTM stainless steel
Screw	Series 305 ASTM stainless steel
Shield	Series 301 ASTM stainless steel
Gasket	High quality neoprene, formulated to meet the physical testing requirements of ASTM C 564.

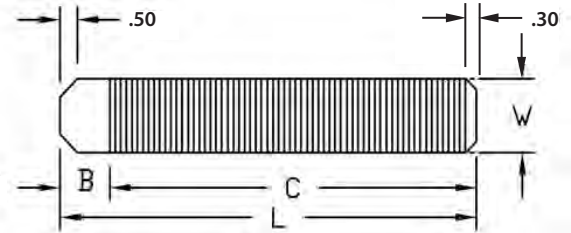

CORRUGATED SHIELD DETAILS

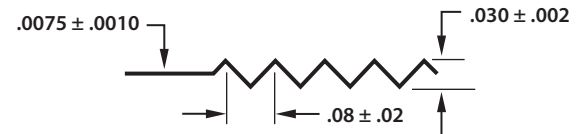

SEALING GASKET DETAILS

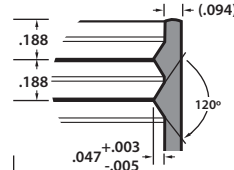

SIZES 1½" - 4"
 2 SEALING
 RINGS/SIDE

SIZES 5" - 10"
 4 SEALING
 RINGS/SIDE

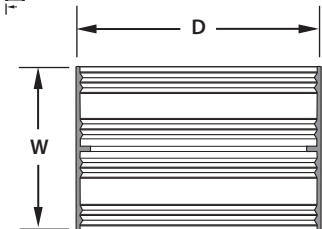
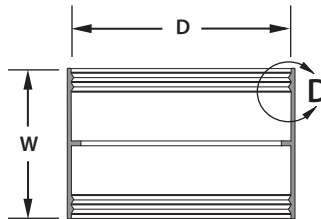

CLAMP DETAILS

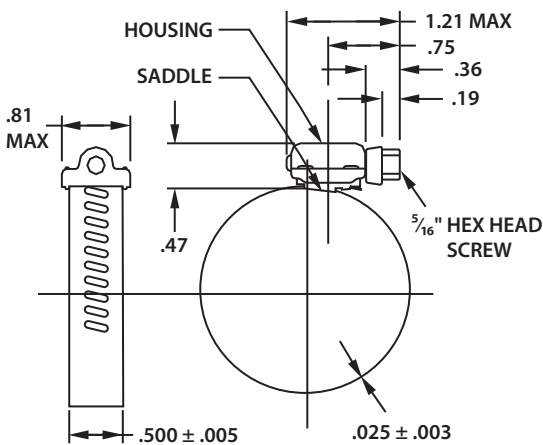

MISSION REFERENCE	CORRUGATED SHIELD DIMENSIONS			
	B	C	L	W
1½" - C150C	1.375	6.125	7.500	2.125
2" - C200C	1.375	7.625	9.000	2.125
2" x 1½" - C215C	1.375	7.625	9.000	2.125
3" - C300C	1.375	10.875	12.250	2.125
3" x 2" - C320C	1.375	10.875	12.250	2.125
4" - C400C	1.375	14.250	15.625	2.125
4" x 2" - C420C	1.375	14.250	15.625	2.125
4" x 3" - C430C	1.375	14.250	15.625	2.125
5" - C500C	2.500	17.750	20.250	3.000
6" - C600C	2.500	20.750	23.250	3.000
8" - C800C	2.688	26.938	29.625	4.000
10" - C1000C	2.688	33.563	36.250	4.000

SEALING GASKET DIMENSIONS	
D	W
1½"	3
2"	3
2" x 1½"	3
3"	3
3" x 2"	3
4"	3
4" x 2"	3
4" x 3"	3
5"	4
6"	4
8"	4
10"	4

TEST	GASKET PHYSICAL TESTS (ASTM C 564)	ASTM C 564
Tensile Strength	1500 PSI minimum	D412
Elongation	250% minimum	D412
Durometer (Shore A)	70 ± 5 @ 76°F ± 5°F	D2240
Accelerated Aging	15% maximum tensile and 20% maximum elongation deterioration. 10 points maximum increase in hardness. All determinations after oven aging for 96 hours at 158°F.	D573
Compression Set	25% maximum after 22 hours at 158°F	D395
Oil Immersion	80% maximum volume change after immersion in ASTM oil #3 for 70 hours at 212°F	D471
Ozone Cracking	No visible cracking at 2X magnification of the gasket after 100 hours exposure in 1.0 PPHM ozone concentration at 104°F. Testing and inspection to be on gasket which is loop-mounted to give approximately 20% elongation of outer surface.	
Tear Resistance	Die C 150 lbs. minimum per inch of thickness	D624
Water Absorption	20% maximum by weight after 7 days at 158°F	D471

Mission's No Hub Coupling is designed to connect cast iron hubless soil pipe and fittings in sanitary and drain waste and vent (DWV) applications. Couplings consist of two (2) or four (4) 301 series stainless steel clamps attached to a 301 series stainless steel corrugated shield, over a molded one-piece elastomeric sealing gasket. Couplings are available in sizes 1½" to 10": 1½" to 4" utilize two (2) clamps; 5" to 10" utilize four (4) clamps.

Leak-Proof Seal - Stainless steel clamps provide a positive seal when properly tightened to 60 in/lbs. of torque. Axially slotted clamps enable bands to tighten independently to accommodate variances in the outside diameters of the pipe and fittings to be joined, ensuring a water-tight, leak-proof and root-proof seal. Sealing "O" Rings are installed under each sealing clamp to prevent pipe slippage and create a more positive seal.

Adaptability - Longer slots on clamps readily adapt to varying cast iron pipe diameters.

Corrosion Resistant - 300 series stainless steel components provide highly effective corrosion resistance in a variety of environments.

Joint Movement Restraint - The No Hub Coupling provides for greater load bearing control between the coupling and pipe surface. The coupling's rugged construction provides excellent sealing properties and the arrangement of the intermittent corrugations of the outer stainless steel shield provides resistance to shear forces and helps with alignment, while maintaining flexibility. The internal profile of the elastomeric gasket against the corrugation is designed to suit specific performance application of non-potable waste systems.

Pre-Set Calibration - All No Hub Couplings are designed to be installed with a pre-set torque wrench calibrated to 60 in/lbs. maximum to accommodate the 305 series stainless steel 5/16" hex head screw.